

NEPOLA TYP 2

Art.-Nr.

302 309
302 313

1350
920
380
mm

1/10
VO





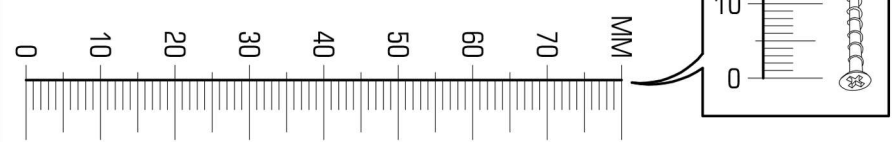
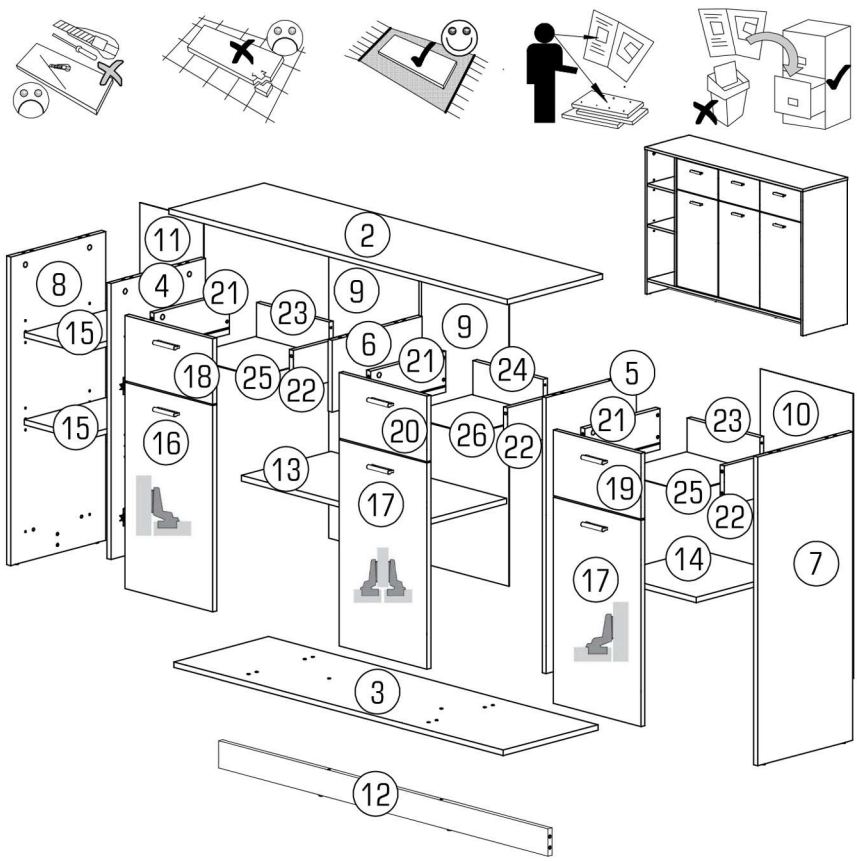

	120 min			PZ1 PZ2	0,5 kg	3m	600 mm	Ø8	4

ID EE	ID			
18399	②	1350*380*16	1x	1/2
18400	③	1314*378*16	1x	1/2
18401	④	808*377*16	1x	2/2
18402	⑤	808*359*16	1x	2/2
18403	⑥	210*359*16	1x	2/2
18404	⑦	904*379*16	1x	2/2
18405	⑧	904*379*16	1x	2/2
18406	⑨	834*358*3	2x	2/2
18407	⑩	834*370*3	1x	2/2
18408	⑪	834*254*3	1x	2/2
18409	⑫	1314*80*16	1x	1/2
18410	⑬	346*358*16	1x	1/2
18411	⑭	700*358*16	1x	1/2
18412	⑮	232*375*16	2x	1/2 2/2
18413	⑯	604*350*16	1x	2/2
18414	⑰	604*350*16	2x	2/2
18415	⑱	350*192*16	1x	2/2
18416	⑲	350*192*16	1x	2/2
18417	⑳	350*192*16	1x	2/2
15743	㉑	300*120*16	3x	1/2
15745	㉒	300*120*16	3x	1/2
18418	㉓	290*100*16	2x	1/2
18419	㉔	280*100*16	1x	1/2
18420	㉕	304*300*3	2x	2/2
18421	㉖	304*290*3	1x	2/2









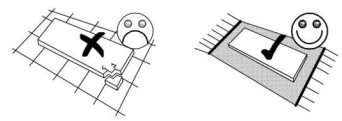
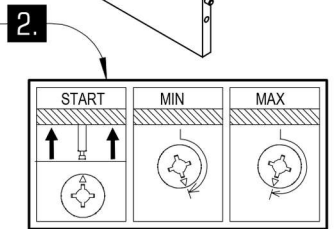
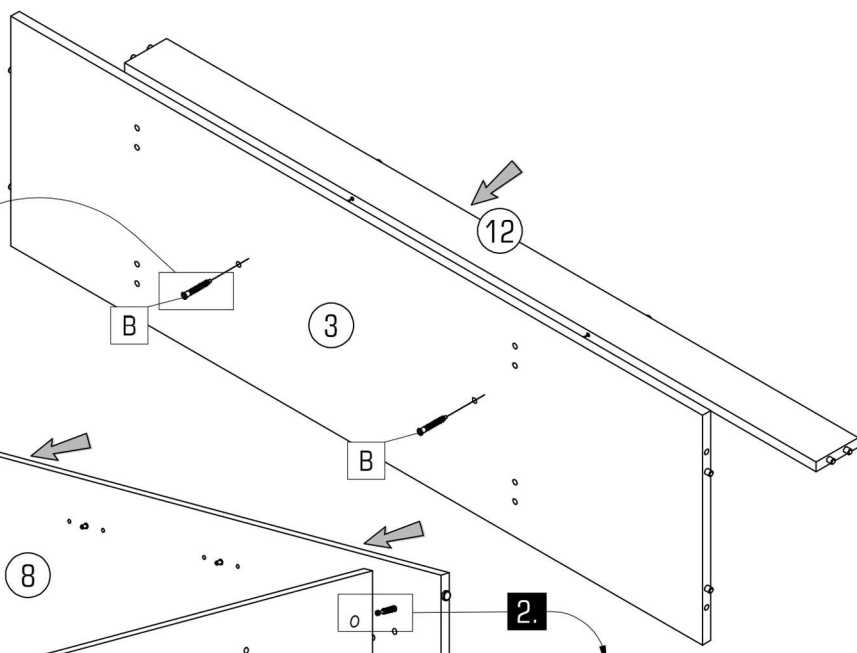
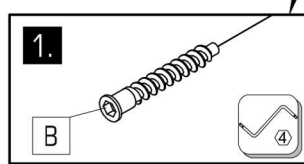
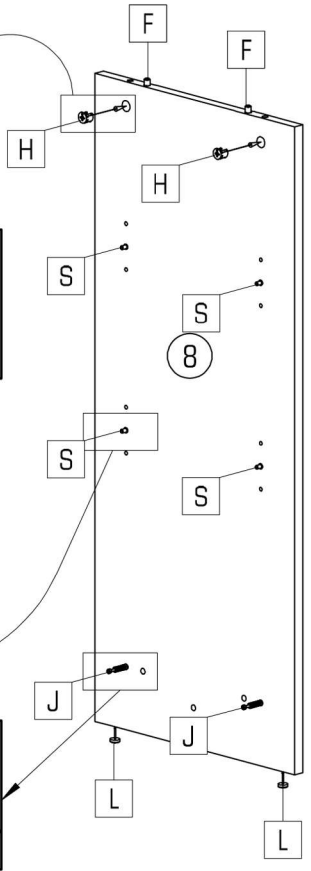
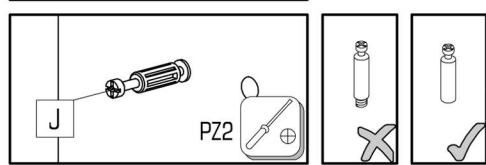
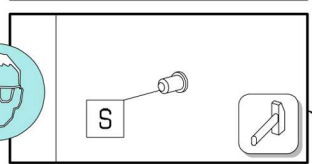
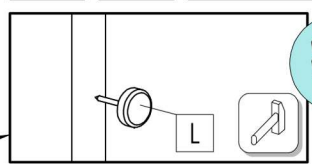
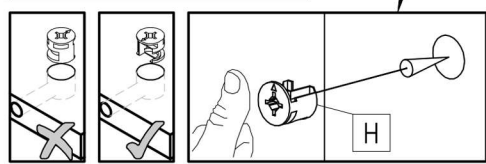
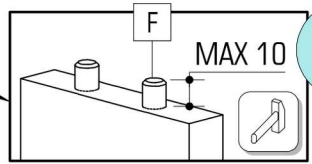
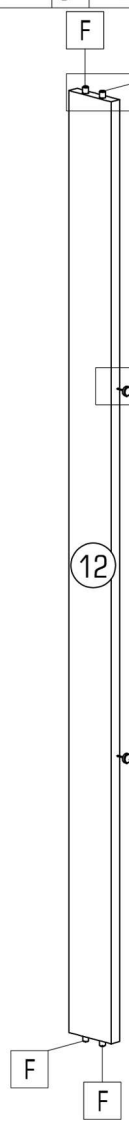
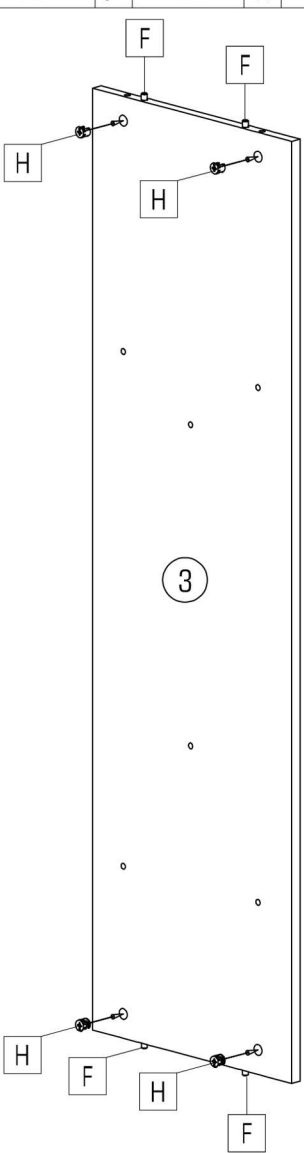

22244,01 A 8x	22300,00 B 18x	21102,00 C 50x	22705,00 D 12x	22705,00 E 1x	27000,00 F 22x	27000,00 G 2x	70013,01 H 26x	70021,01 I 26x	70021,01 J 26x
22430,00 K 12x	30091,00 L 6x	32314,02 M 6x	22705,00 N 22x	33003,00 P1 3x	33003,00 P2 3x	22243,00 Q 30x	24008,00 R 16x	35101,01 S 16x	22213,00 T 1x
24103,00 U 1x	31103,00 V 1x	22236,00 W 16x	36001,01 X1 4x	36001,01 X2 4x	36013,02 Y1 2x	36013,02 Y2 2x	36013,02 Z1 2x	36013,02 Z2 2x	36013,02 Z3 2x

		CLEAN							

					
B 2x	F 10x	H 6x	J 2x	L 4x	S 4x



								
B 4x	D 6x	F 8x	H 4x	P1 3x	Q 3x	S 10x	X2 2x	Y2 2x

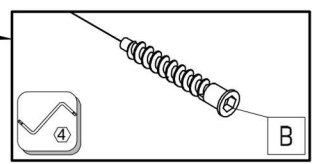
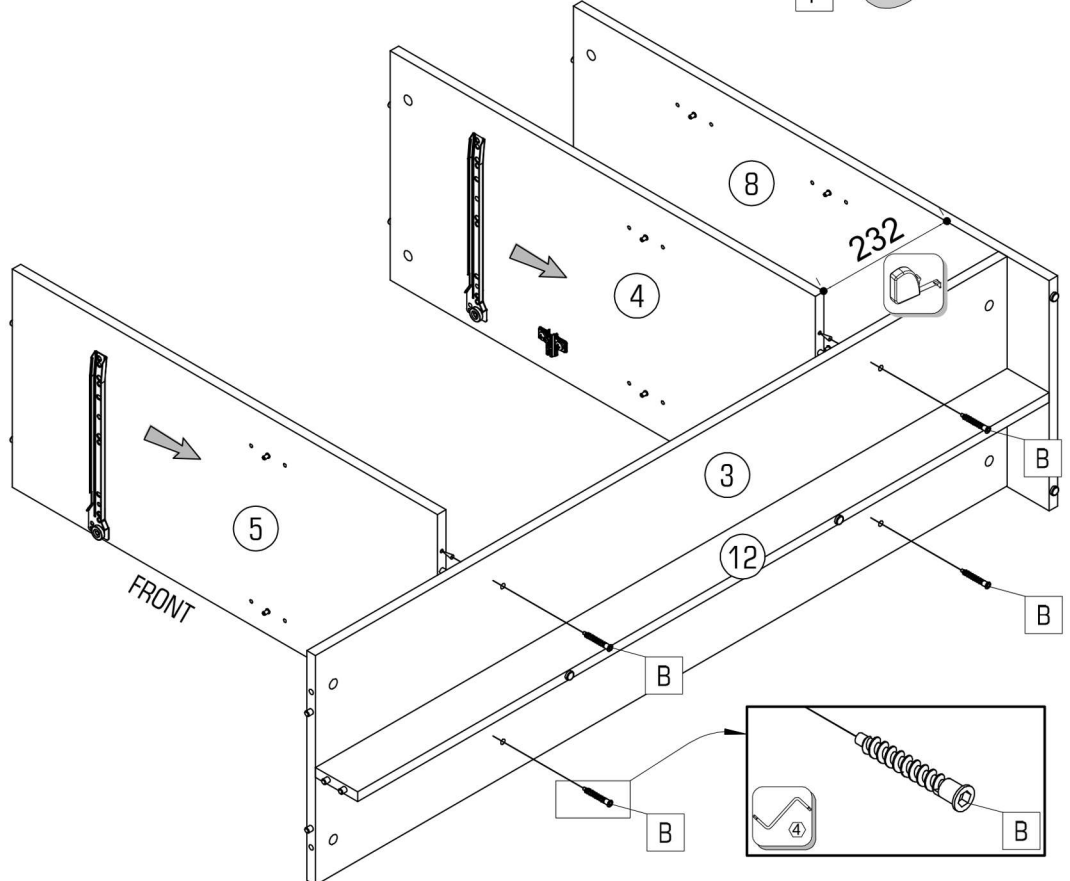
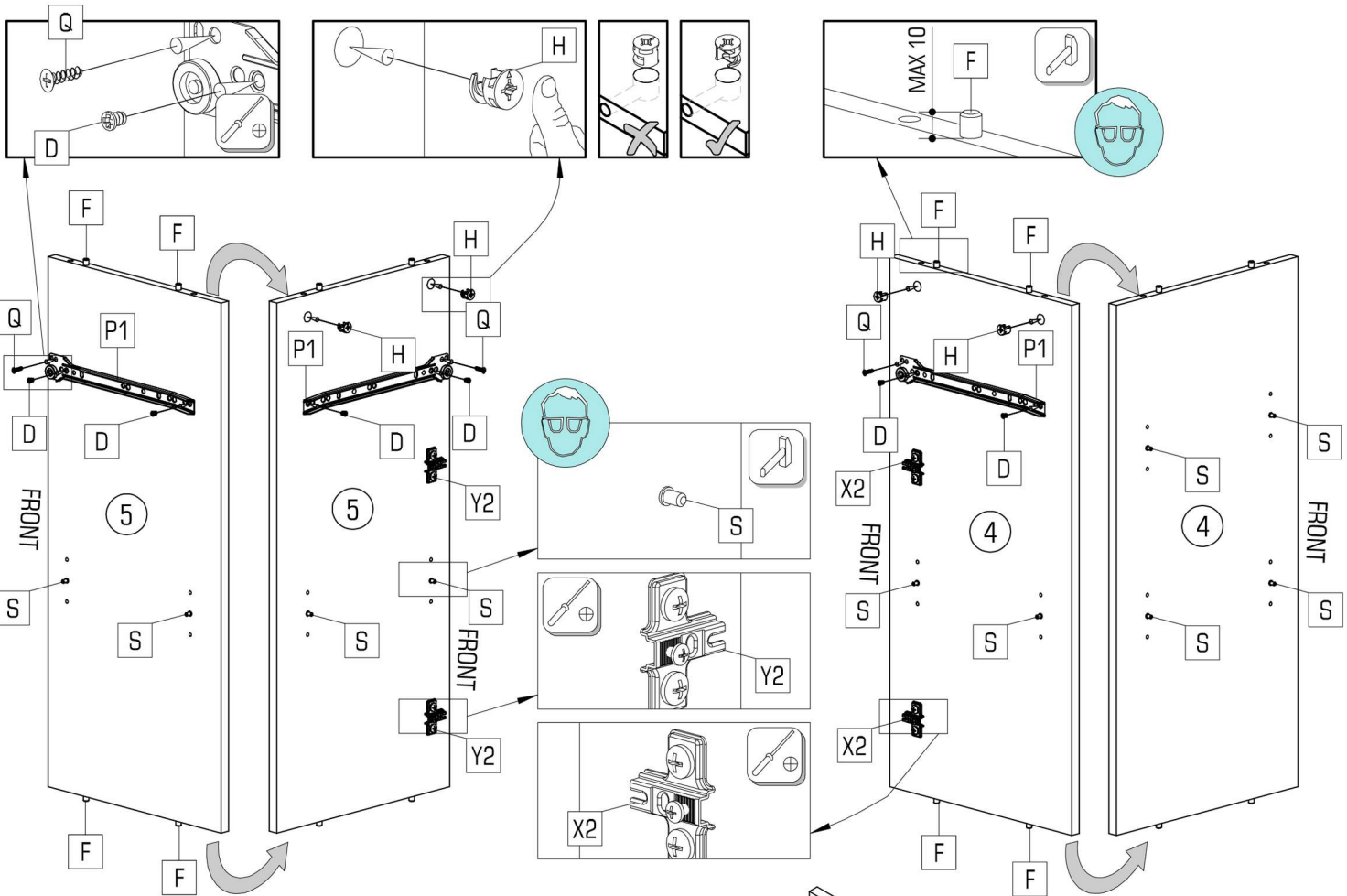

D 2x	F 2x	H 2x	J 2x	L 2x	P1 1x	Q 1x	S 2x	X2 2x

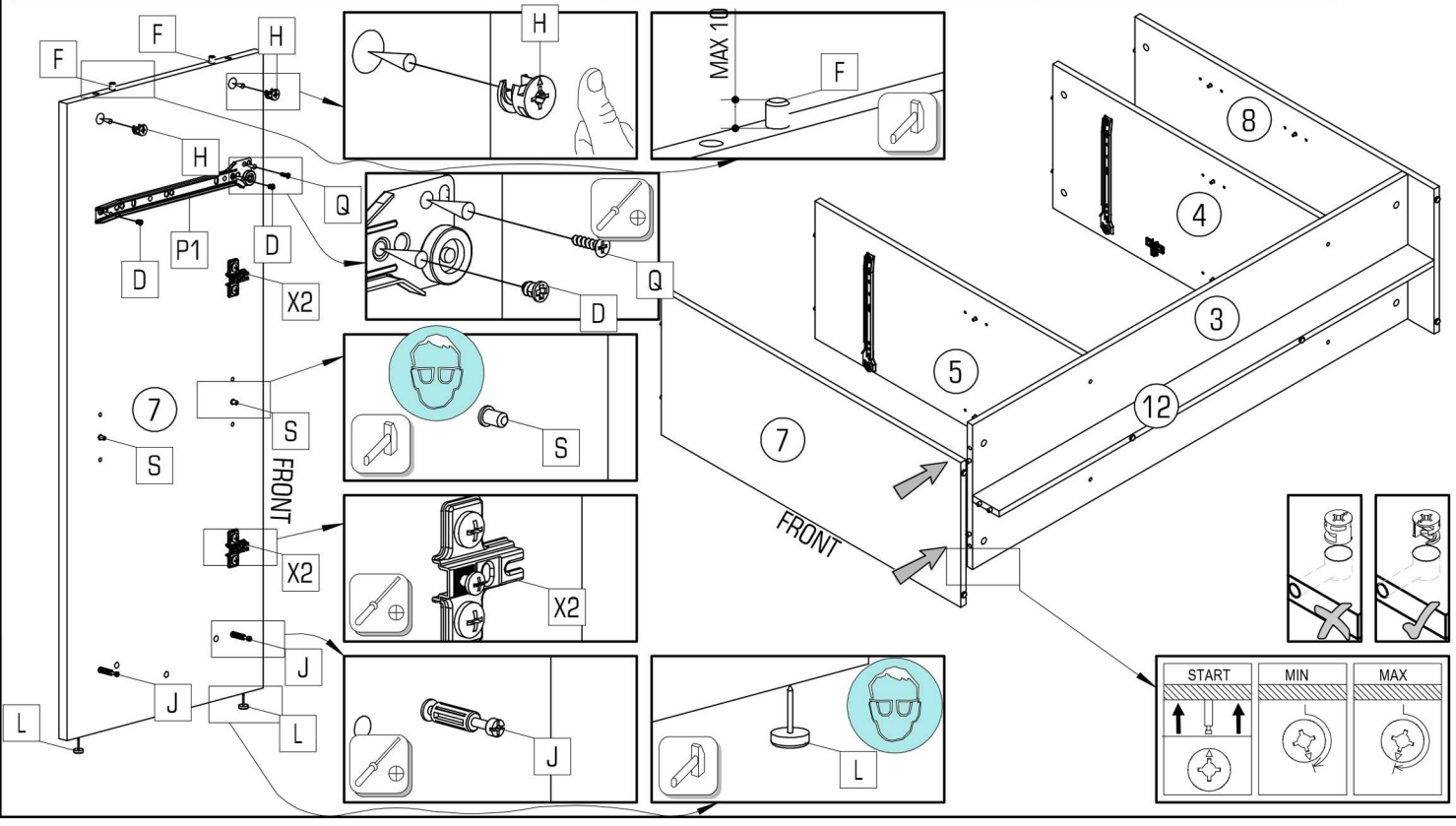

A 1x	D 4x	F 2x	H 2x	J 10x	P1 2x	Q 2x	V 1x

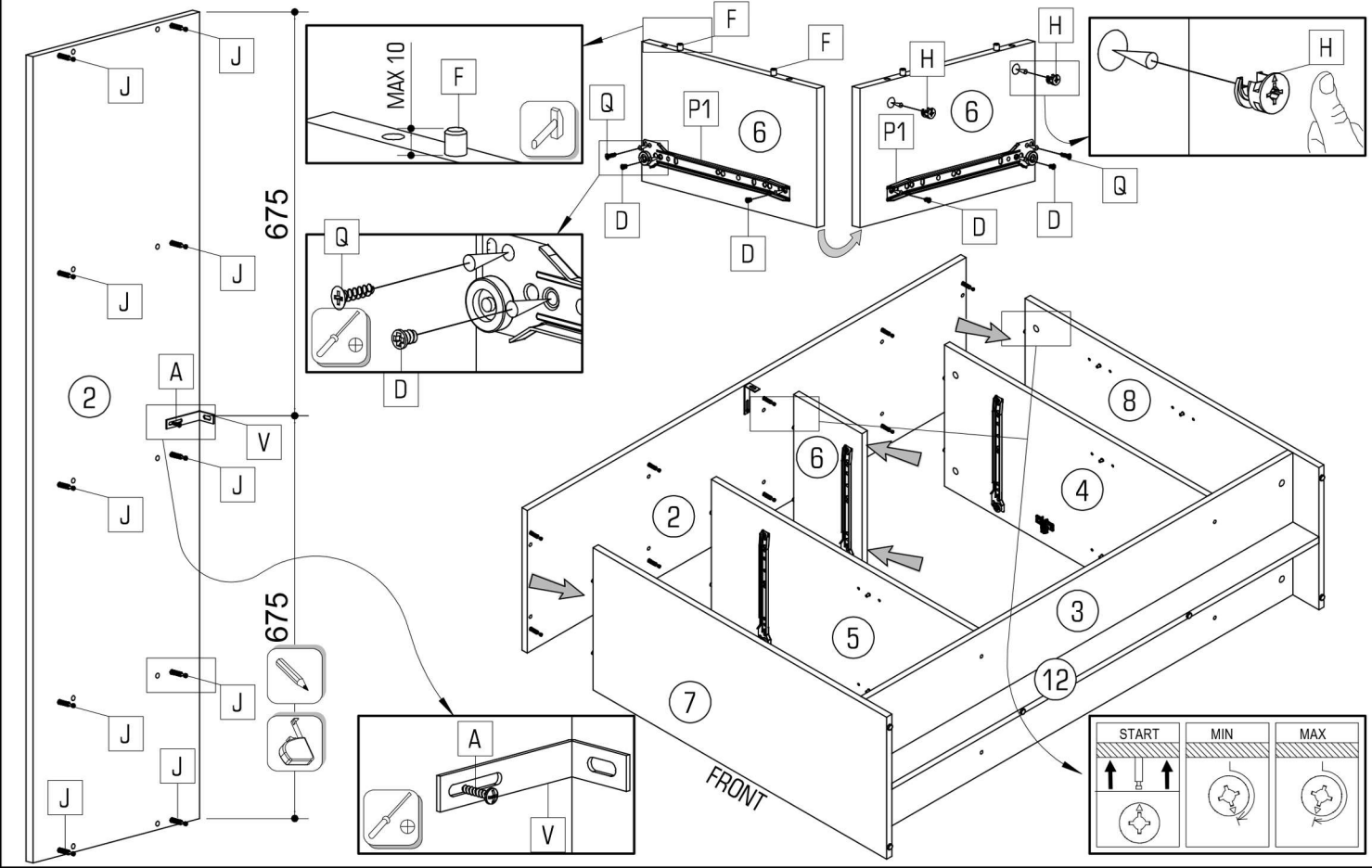

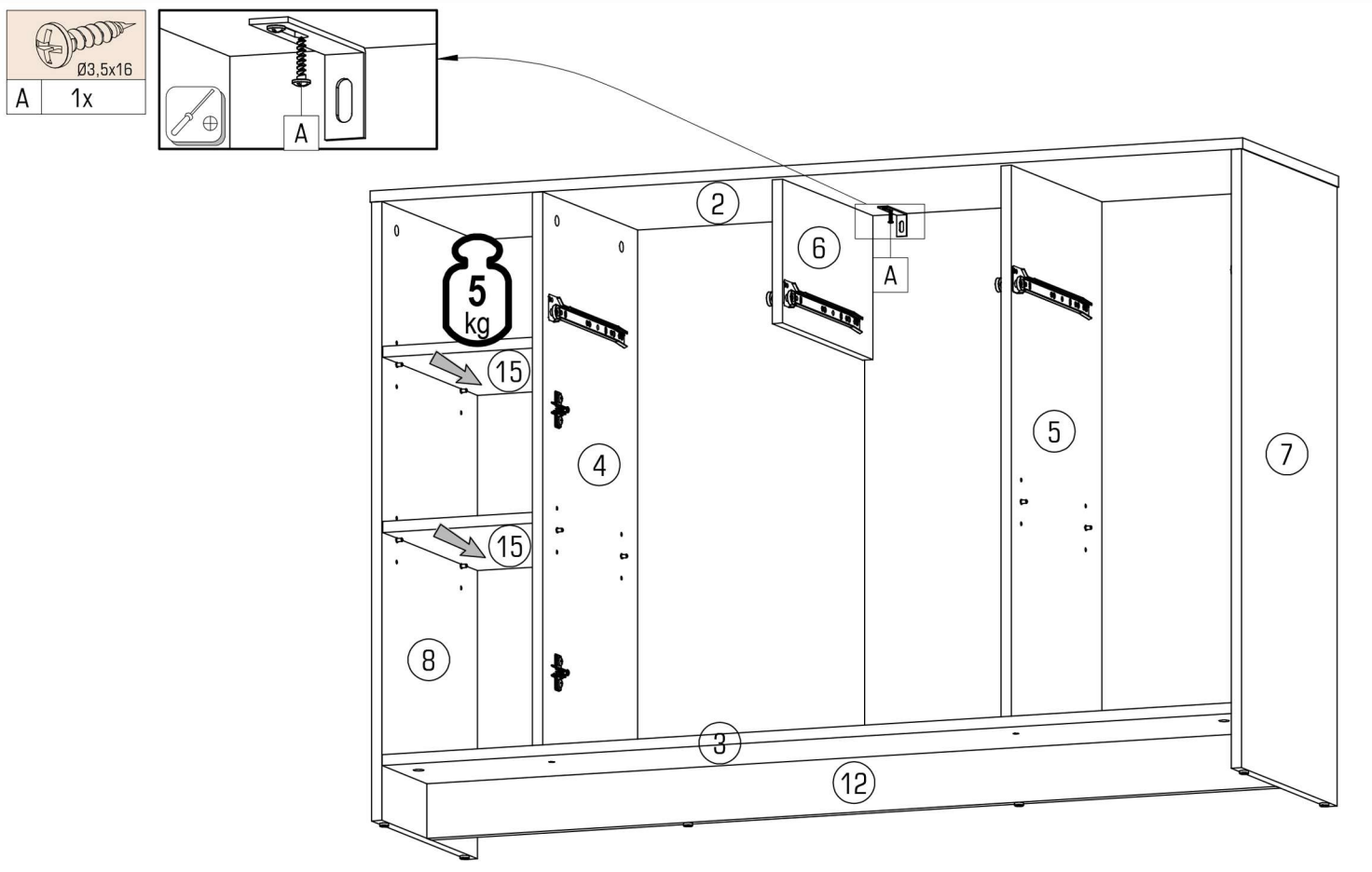
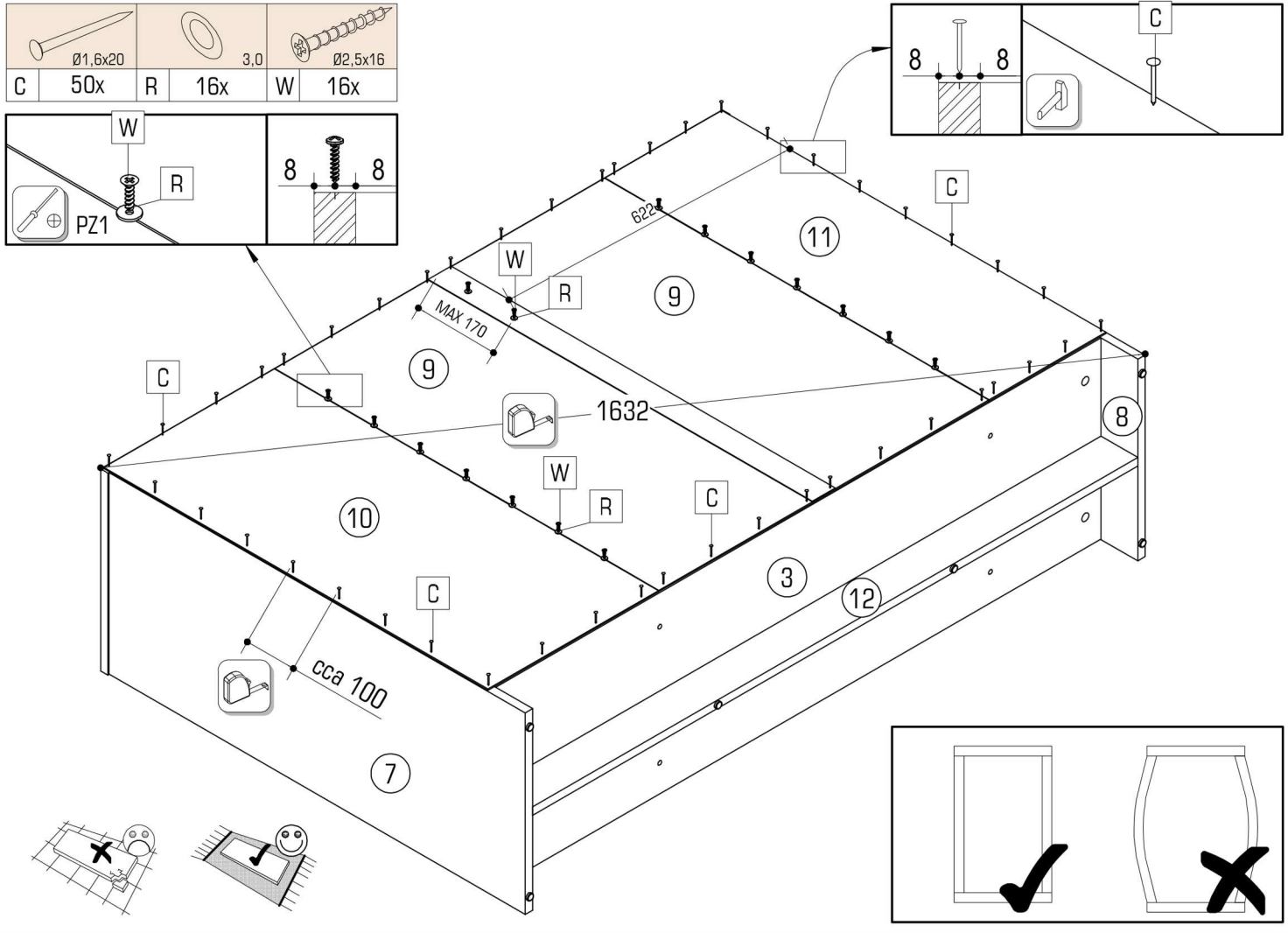

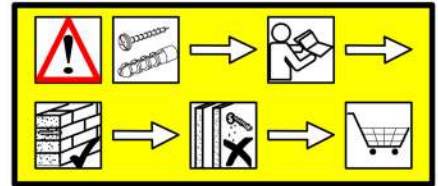
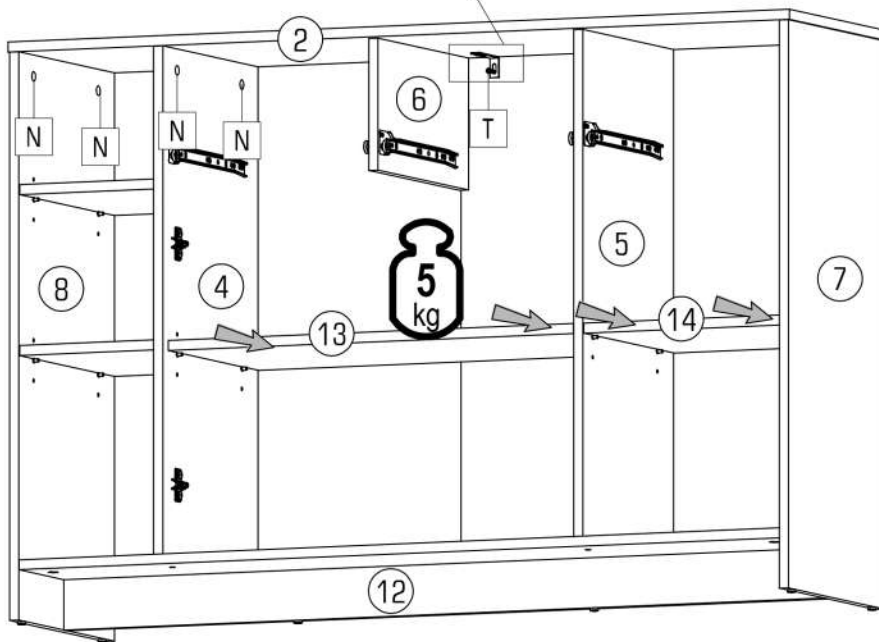
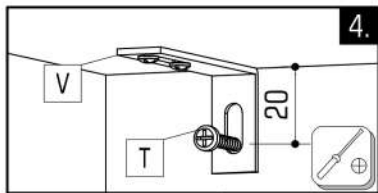
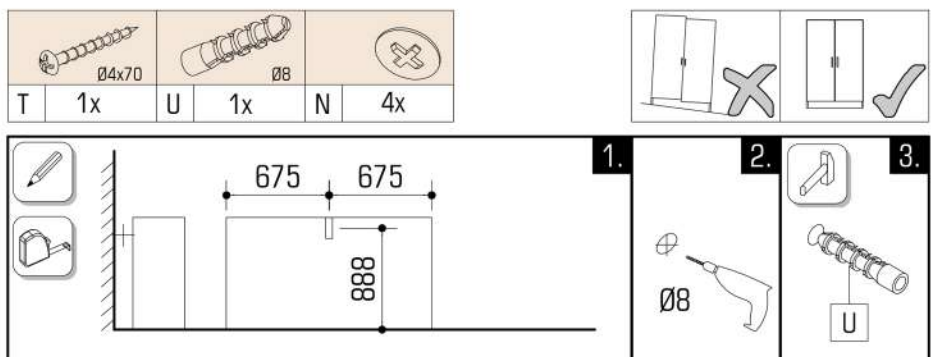

Upozornenie! Pevnosť steny sa musí pred montážou bezpodmienečne skontrolovať. Univerzálne hmoždenky, ktoré sú obsiahnuté v balení, používajte jedine pre pevné murovo ako je betón/tehla. Hmoždenky sa nesmú používať v prípade ľahkého stavebného muriva, dutina tehla, u sádkartónových dosiek alebo iných konštrukcií rámu. U týchto murív je nutné použiť špeciálne hmoždenky! Tieto je možné dostať v špeciálnych predajniach so stavebným materiálom (stavebniny). Pri nedodržaní pokynov nepreberajú výrobcovia/predajci a dodávateľa zodpovednosť za vzniknuté škody.

Upozornění! Před montáží je nutné zkontrolovat stav stěny. Přiložené univerzální hmoždinky jsou určeny pouze k použití pro pevné zdivo jako beton/cihly. Hmoždinky do zdi se nesmí používat u dutinová cihla, zdiva jako pórovitý stavební kámen, sádkartónová deska nebo jiný měkký materiál. U těchto zdív jsou nutné použít speciální hmoždinky! Jsou k dostání v speciálních prodejnách se stavebním materiálem. Při nedodržení těchto pokynů výrobce/prodejce a dovozce neručí za způsobené škody.

Pažnja! Prije montaže obavezno provjerite svojstvo zida. Priložene univerzalne tiple namijenjene su isključivo za masivne zidove od betona/opeke. Tiple za masivne zidove ne smiju se koristiti za zidove kao npr šupljina opeka laki sastavni elementi, gips-kartonske ploče ili drugi modularni načini gradnje. Za te zidove potrebne su eventualno specialne tiple! Iste su dostupne u specijaliziranim trgovinama građevinskim materijalom. U slučaju nepridržavanja prethodno navedenih napomena, proizvođač/trgovac i uvoznik ne preuzimaju odgovornost!

Achtung! Die Wandbeschaffenheit ist vor der Montage unbedingt zu prüfen. Die beigelegten Universaldübel sind ausschließlich nur zur Verwendung für festes Mauerwerk wie Beton/Ziegel. Die Mauerdübel dürfen nicht bei Mauerwerk wie Hohlraumziegel, Leichtbausteinen, Gipskartonplatte oder anderer Rahmenbauweise verwendet werden. Bei diesen Mauerwerken sind gegebenenfalls Spezialdübel zu verwenden! Diese sind in einem Fachgeschäft (Baumarkt) erhältlich. Bei Nichteinhaltung wird seitens Produzenten/Händler und Importeur keine Haftung übernommen.

Vigyázat! Szerelés előtt a falfelületet feltétlenül vizsgálja meg. A mellékelt univerzális tiplik kizárólag stabil falazathoz használható mint például beton/tégla. A fali tiplik nem használható könnyű építőkövekhez, üreg tégla, gipszkarton lapokhoz vagy más fűvázas építmenyokhez. Ezekhez a falfelületekhez csak speciális tiplik használhatóak, melyek szaküzletekben (barkácsáruházakban) beszerezhetőek. Fentiek figyelmen kívül hagyása esetén a gyártó/kereskedő vagy forgalmazó nem vállal felelősséget.





Uwaga! Ściane należy sprawdzić przed montażem. Dołączone uniwersalne kołki rozporowe są odpowiednie tylko do stosowania w mocnych murach, takich jak beton lub cegła. Nie rób z pomocą kołków rozporowych murowanych, takich jak pustak, lekka kostka, powierzchnie takie jak płyty gipsowo-kartonowe lub inne systemy ram. Jeśli dotyczy, muszą to być określone kołki rozporowe być użyłym! Są one dostępne w specjalistycznym sklepie (sklepie ze sprzętem) niezgodność, producent / sprzedawca lub importer nie ponoszą odpowiedzialności.

Prudență! Zidul trebuie examinat înainte de asamblare. Prileze de perete sunt adecvate numai pentru utilizarea în zidărie fermă, cum ar fi betonul bloc sau cărămidă. Nu folosiți zidăria zidurilor de perete, cum ar fi cărămida goală, blocul ușor, suprafețe cum ar fi gips-carton sau altă încădrare sisteme. Dacă este cazul, trebuie folosite anumite prize de perete! Acestea sunt disponibile la un magazin specializat (magazin de hardware). În caz de nerespectare, producătorul / vânzătorul cu amănuntul sau importatorul nu își asumă răspunderea.

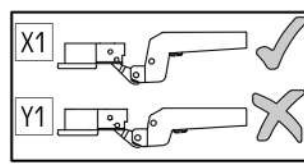
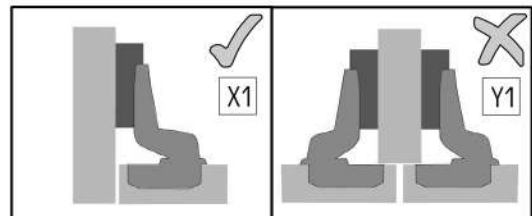
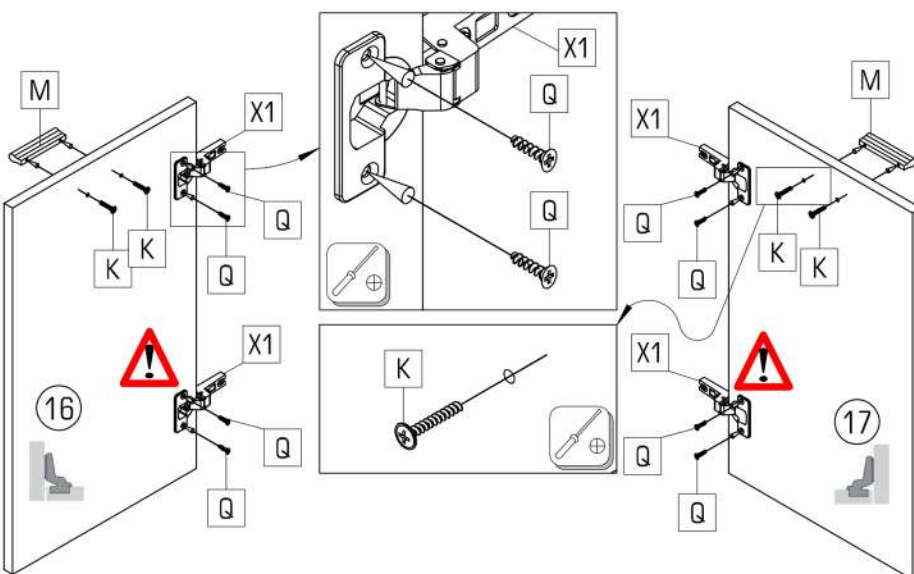
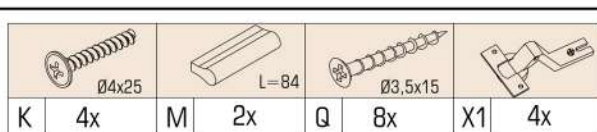

Увара! Стан стіни необхідно перевірити перед установкою. Укладені універсальні дюбелі призначені лише для використання з фіксованими Кладка, як бетон / цегла. Анкери для стін не повинні використовуватися для кладки Порожни цегли, легкі будівельні блоки, гіпсокартон або інша каркасна конструкція бути використаними. З цієї кладкою можуть застосовуватися спеціальні дюбелі використанні! Вони доступні в спеціалізованому магазині (магазині апаратних засобів) Виробник / дилер та імпортёр не несе відповідальності.

Pozor! Před montáží preverite stanje stene. Priloženi univerzalni mozniki so izključno samo za uporabo na čvrstem zidovju, kot sta beton in opeka. Stenski mozniki se ne smejo uporabljati pri zidovju kot so votlino opeke, zidaki za lahko gradnjo, mavčne plošče ali druge okvirne gradnje. Pri teh zidovjih morate v danih primerih uporabljati posebne moznike. Ti so na voljo v specializiranih trgovinah (trgovinah z gradbenim materijalom) Pri upoštevanju se s strani proizvajalca/trgovca in uvoznika ne prevzame jamstvo.



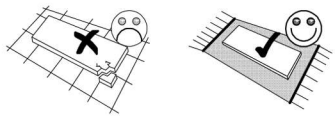
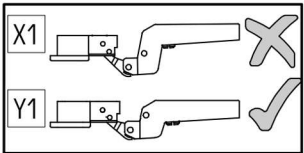
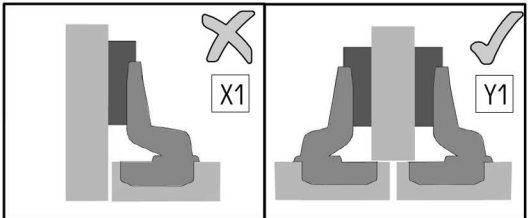
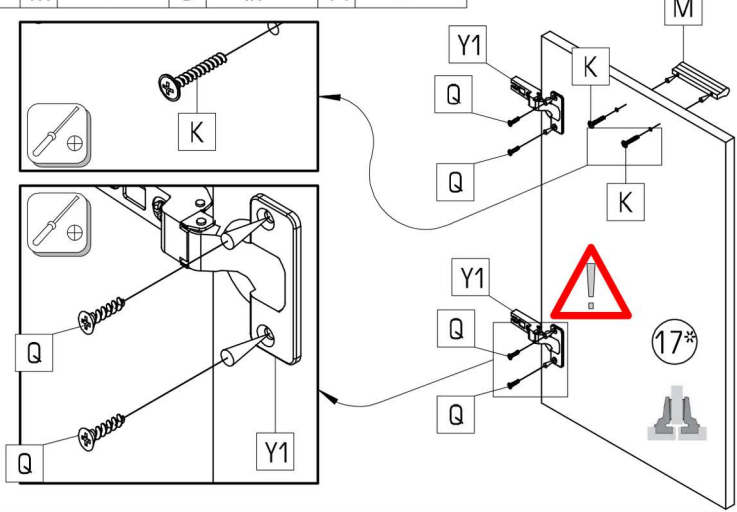

 Ø4x25	 L=84	 Ø3,5x15	
K 2x	M 1x	Q 4x	Y1 2x



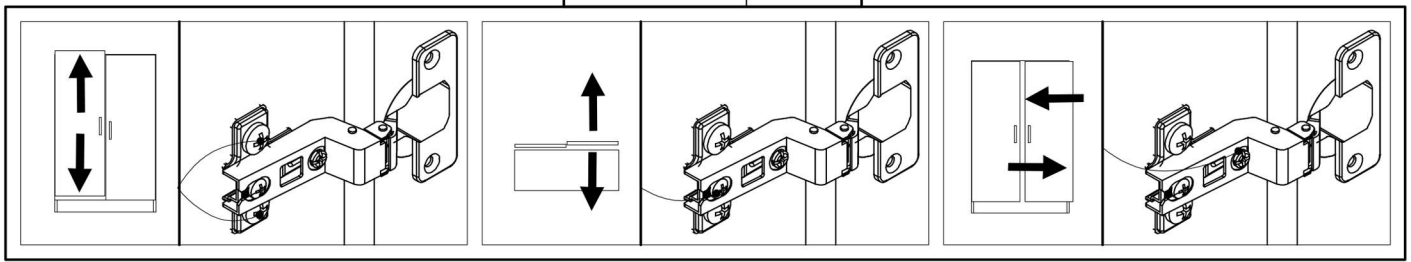
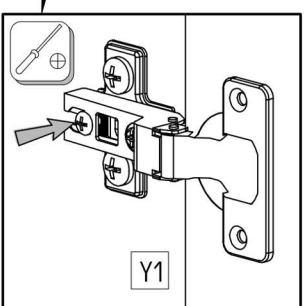
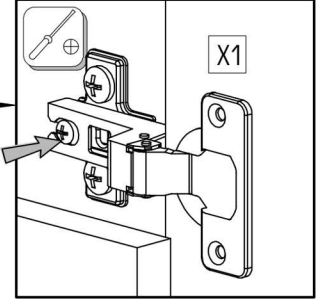
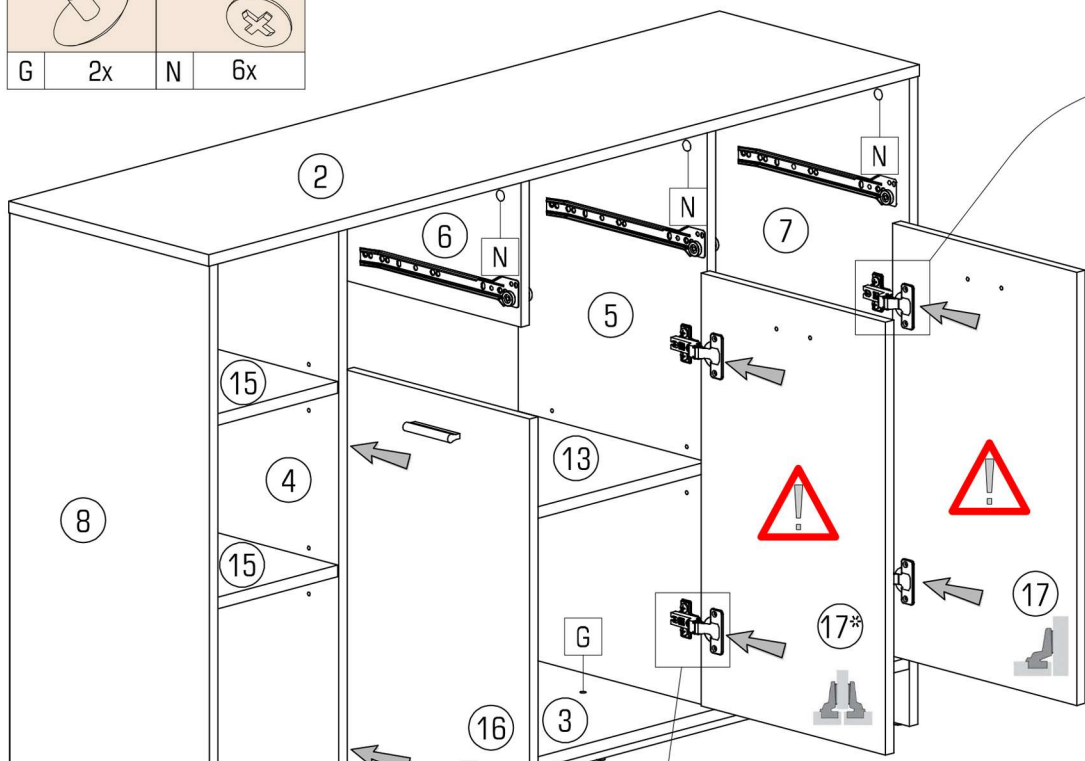

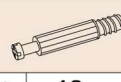
	
G 2x	N 6x



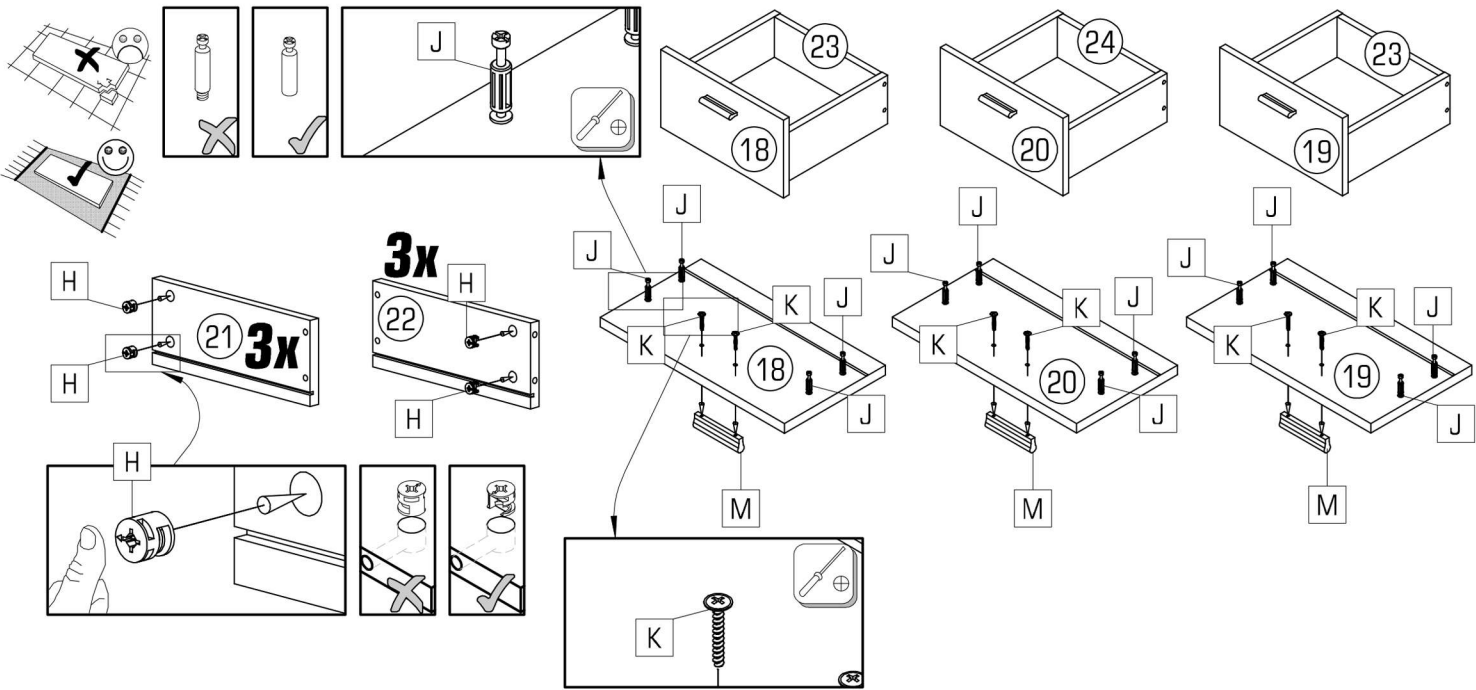

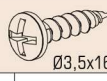
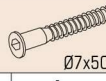

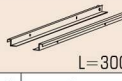
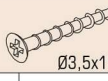
			
H 12x	J 12x	K 6x	M 3x

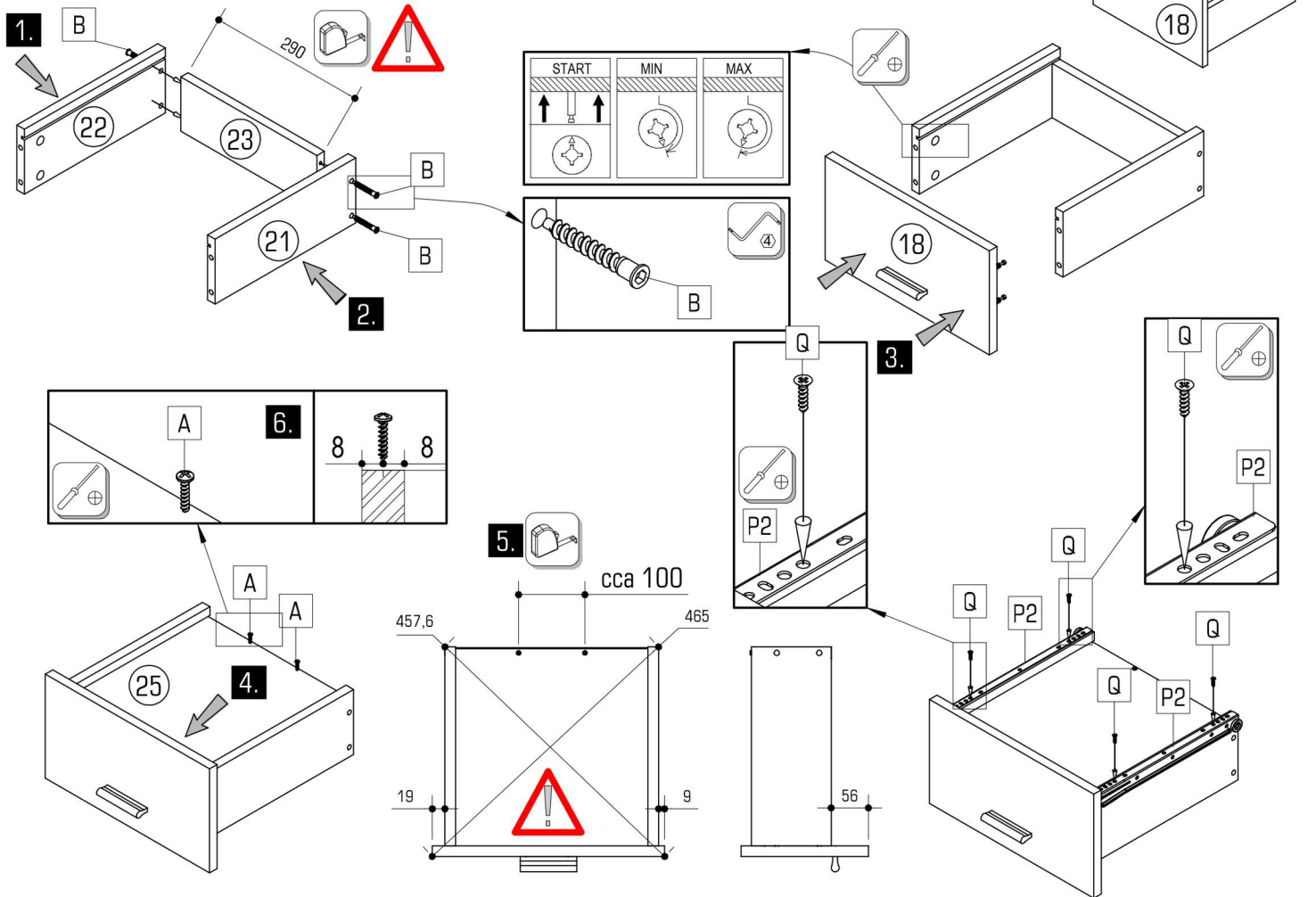





				
A 2x	B 4x	N 4x	P2 1x	Q 4x

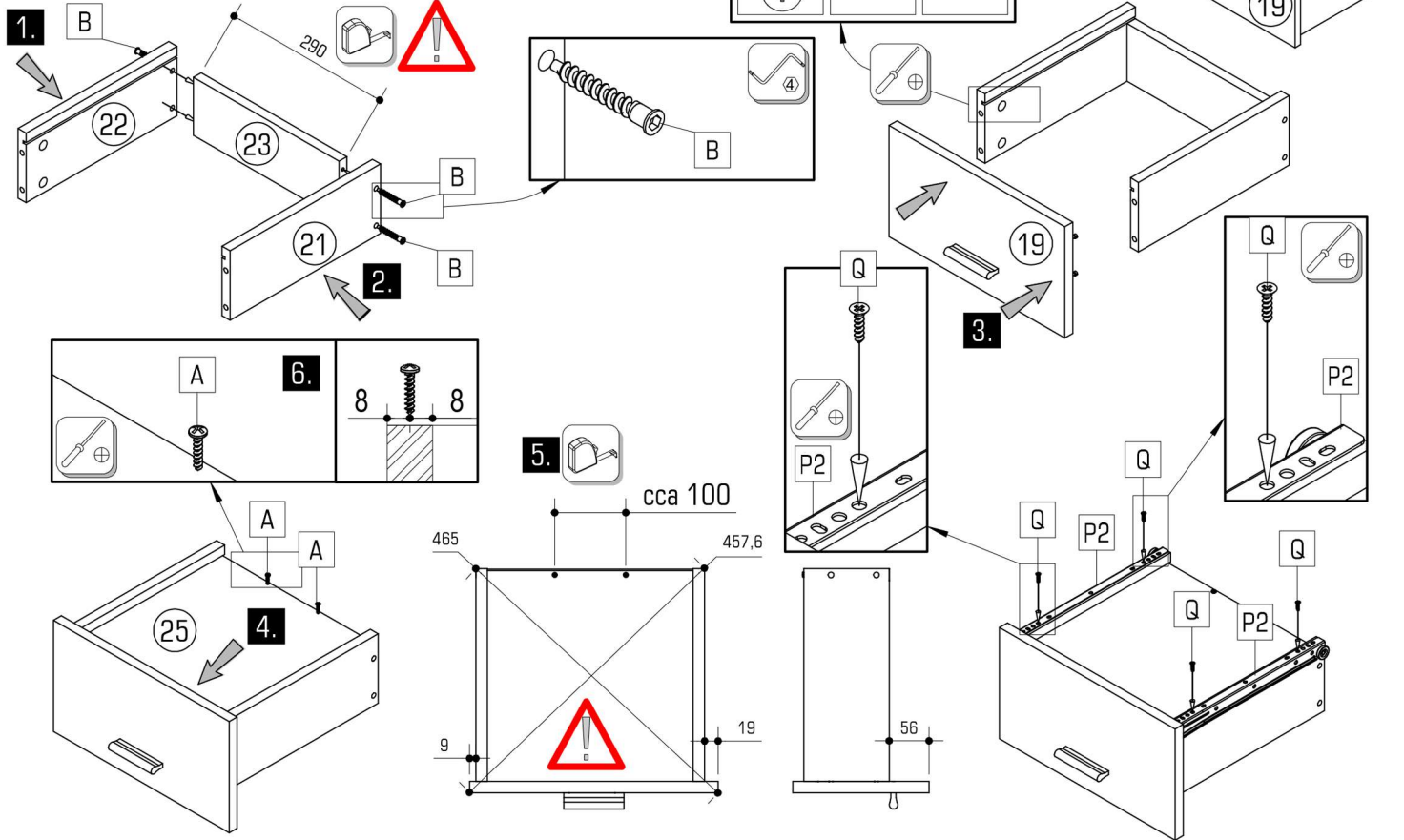
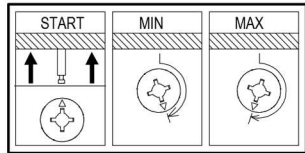

				
A	B	N	P2	Q
2x	4x	4x	1x	4x



				
A	B	N	P2	Q
2x	4x	4x	1x	4x

